

Body & Hair Care Dispenser Installation instructions

Package contents

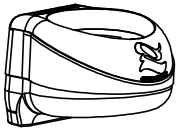

Dispenser



Cap
(Medium)

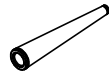

Glue tube

Safety points

1. Keep out of reach of children
2. To be used with hair shampoo, hair conditioner, body soap, body lotion, hair cream, hand cream
3. Maximum bottle size for dispenser - 1,250ml
4. Dispenser should not be left empty of cleaning products for long periods

Installation instructions

1 Dispenser installation

Carefully clean the area of oils and dirt and dry thoroughly



- 2** Remove the seal from the double sided tape (B) at the back of the dispenser



- 3** Open the tube of glue (included in the package) and dispense the content evenly on the track (C) at the back of the dispenser. Press the dispenser into place

Press and apply strong pressure for 10 seconds !

The glue tube should be kept in a dark place at temperature between 5-25 degrees celsius

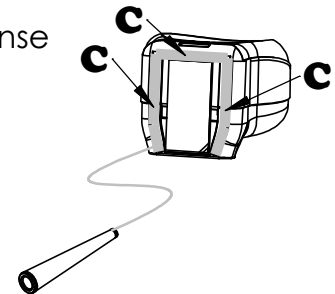

- 4** You must allow 24 hours to completely dry prior to loading a disposable bottle !
(a bottle should not be installed until the glue has completely dried)

Loading the dispenser and cap replacement for disposable bottle (first loading after 24 hours)

1. Remove the cap from the purchased bottle (use a cloth or paper towel)
2. Install the dispenser cap (2) included in the package to the bottle
For easy removal and installation, use a cloth or paper towel to swap the cap(2) between bottles effortlessly
3. To Load the bottle onto the dispenser the bottle should be tilted and inserted fully in place
4. To replace the bottle, the bottle should be tilted and removed from the dispenser
5. Usage instructions: Squeeze the bottle (5) until the liquid comes out of the bottom of the dispenser

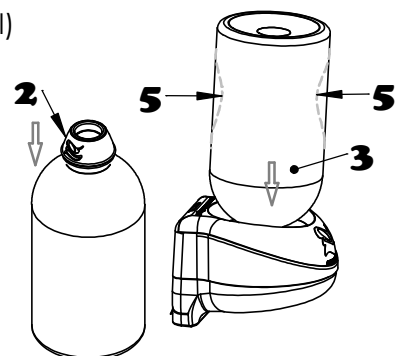

Hands/Dishwashing dispenser Installation instructions

Package contents

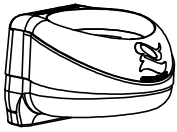

Dispenser



Cap
(Medium)

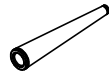

Glue tube

Safety points

1. Keep out of reach of children
2. To be used with hair shampoo, hair conditioner, body soap, body lotion, hair cream, hand cream
3. Maximum bottle size for dispenser - 1,250ml
4. Dispenser should not be left empty of cleaning products for long periods

Installation instructions

1 Dispenser installation

Carefully clean the area of oils and dirt and dry thoroughly



- 2** Remove the seal from the double sided tape (B) at the back of the dispenser



- 3** Open the tube of glue (included in the package) and dispense the content evenly on the track (C) at the back of the dispenser. Press the dispenser into place

Press and apply strong pressure for 10 seconds !

The glue tube should be kept in a dark place at temperature between 5-25 degrees celsius

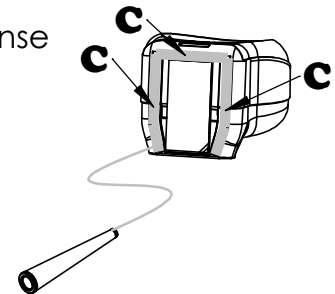

- 4** You must allow 24 hours to completely dry prior to loading a disposable bottle !
(a bottle should not be installed until the glue has completely dried)

Loading the dispenser and cap replacement for disposable bottle (first loading after 24 hours)

1. Remove the cap from the purchased bottle (use a cloth or paper towel)
2. Install the dispenser cap (2) included in the package to the bottle
For easy removal and installation, use a cloth or paper towel to swap the cap(2) between bottles effortlessly
3. To Load the bottle onto the dispenser the bottle should be tilted and inserted fully in place
4. To replace the bottle, the bottle should be tilted and removed from the dispenser
5. Usage instructions: Squeeze the bottle (5) until the liquid comes out of the bottom of the dispenser

